

Pedestrian Autonomous Emergency Braking Test Protocol

Version IV DRAFT

July 2023



Insurance Institute for Highway Safety

988 Dairy Road

Ruckersville, VA 22968

researchpapers@iihs.org

+1 434 985 4600

iihs.org



Contents

DOCUMENT REVISION HISTORY	3
SUMMARY	4
TEST ENVIRONMENT	5
Surface and markings	5
Surroundings	5
Ambient conditions	6
TARGET	6
Pedestrian target system for P-AEB testing	6
TEST VEHICLE PREPARATION	7
General	7
Instrumentation.....	7
Brake warm-up and maintenance	8
P-AEB initialization	8
P-AEB and FCW system setting	8
TESTING	8
Pedestrian target speed	8
Target placement: perpendicular adult test.....	8
Target placement: perpendicular child test.....	9
Target placement: parallel adult test	9
Test trials	10
Test vehicle width and overlap position.....	10
Test vehicle speed	10
Test vehicle approach.....	10
Activation of autonomous emergency braking.....	11
Forward collision warning.....	11
Impact point.....	11
DATA ANALYSIS	12
Lateral and longitudinal positions	12
Longitudinal acceleration.....	12
Speed	12
Speed reduction	12
Yaw rate	12
SCORING AND RATING SYSTEM	13
REFERENCES	15

DOCUMENT REVISION HISTORY

Revisions from Version III to Version IV of this protocol:

Updated rating calculations based on the daytime child scenario and nighttime adult scenarios.

Revisions from Version II to Version III of this protocol:

Added descriptions for nighttime pedestrian testing.

Revisions from Version I to Version II of this protocol:

Changed the test temperature range and wording to clarify target location, sun glare conditions, and scoring.

DRAFT

SUMMARY

This protocol describes the test procedure used to evaluate pedestrian autonomous emergency braking (P-AEB) systems on passenger vehicles similar to those that have been documented to help drivers avoid collisions with pedestrians (Cicchino, 2022; Highway Loss Data Institute, 2018).

This protocol is available from the *Test protocols and technical information* section of the Insurance Institute for Highway Safety (IIHS) website.

The procedure simulates vehicle collisions with (1) an adult pedestrian crossing a street on a path perpendicular to the travel line of a vehicle at night in the dark, (2) a child pedestrian crossing a street from behind an obstruction on a path perpendicular to the travel line of a vehicle during the day, and (3) an adult pedestrian near the edge of a road on a path parallel to the travel path of a vehicle at night.

Ratings are based on a test vehicle's ability to avoid or mitigate pedestrian dummy collisions at 20 and 40 km/h (perpendicular path scenarios) and at 40 and 60 km/h (parallel path scenario). A summary of these test scenarios is included in Table 1.

Table 1
P-AEB Test Scenarios

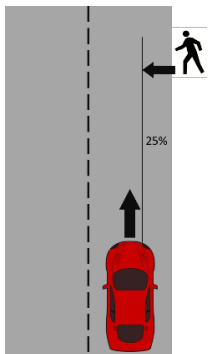
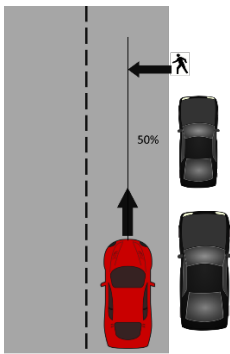
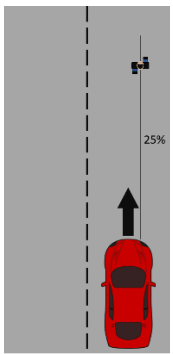
<i>Parameter</i>	<i>Scenario</i>		
	Perpendicular adult (CPNA-25)	Perpendicular child (CPNC-50)	Parallel adult (CPLA-25)
Test vehicle speed	20, 40 km/h	20, 40 km/h	40, 60 km/h
Pedestrian target speed	5 km/h	5 km/h	0 km/h
Target direction	Crossing (R-to-L)	Crossing (R-to-L)	Facing away
Target path (relative to test vehicle)	Perpendicular	Perpendicular	Parallel
Pedestrian dummy size	Adult	Child	Adult
Lighting condition ^a	Night	Day	Night
Dark headlight condition	High and low beams	NA	High and low beams
Dummy articulation (fixed rate)	Yes	Yes	No (stationary)
Overlap	25%	50%	25%
Obstructed	No	Yes	No
Number of valid runs	3	3	3
Test diagram			

Note. NA = not applicable.

^a For P-AEB systems that are not influenced by ambient lighting (i.e., radar only systems), nighttime tests may be conducted during the day.

TEST ENVIRONMENT

Surface and markings

Tests are conducted on a dry asphalt surface without visible moisture. The surface is straight and flat, with a maximum 1% lateral slope for water management. The asphalt must be in good condition, free of potholes, bumps, and/or cracks that could cause the test vehicle to pitch or roll excessively.

Testing is conducted in the right lane of a two-lane roadway. The roadway is marked with continuous solid white lane markers on the outsides and dashed white lane markers in the center. The lane widths are 3.66 m (12 ft), and the dashed lines are 3.05 m (10 ft) in length, separated by 9.14 m (30 ft). The width of the lines is 0.1 m (4 in). These dimensions are illustrated in Figure 1.

Figure 1

Lane markings

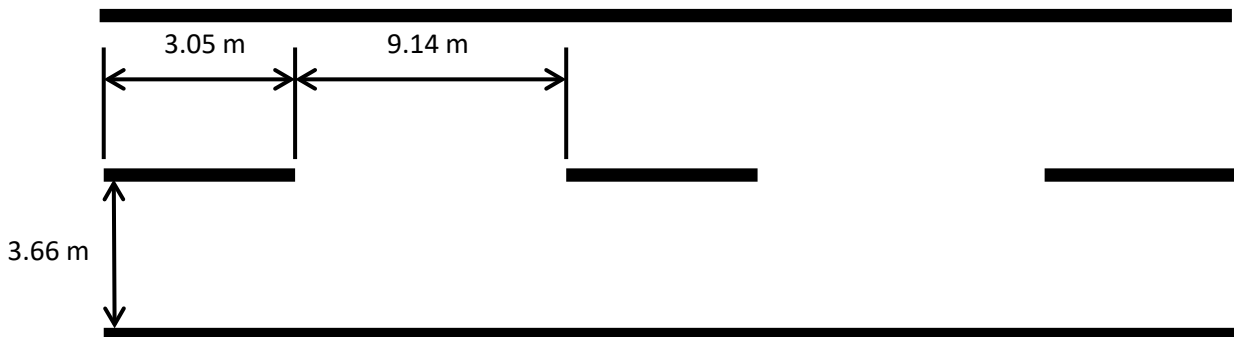

Surroundings

During testing, no other vehicles, obstructions, or objects (except those prescribed in a test scenario) are permitted within a distance of 3 m (9.8 ft) on either side of the test lane or 25 m (82.0 ft) longitudinal distance from the test target. Overhead signs, bridges, gantries, or other significant structures within the lane must be more than 5 m (16.4 ft) above the ground. Open space requirements are illustrated in Figure 2.

Figure 2

Open space around target

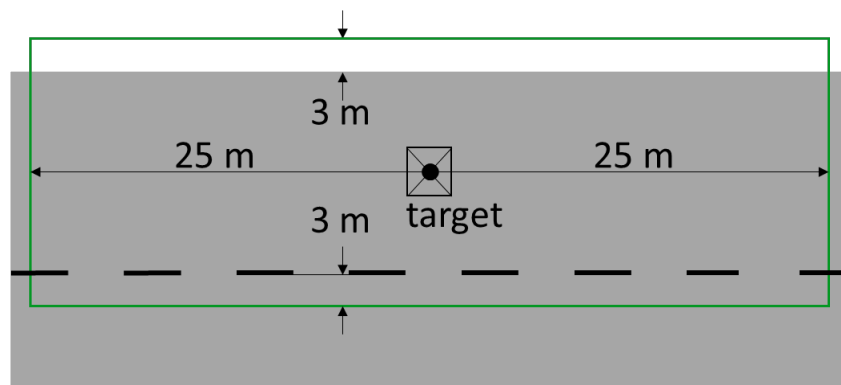

Ambient conditions

Testing is not conducted during periods of inclement weather. This includes, but is not limited to, rain, snow, hail, fog, smoke, and/or ash. Nighttime testing is conducted on the IIHS covered track and can take place during rain or snow as long as the track surface remains dry. The ambient air temperature must be between -6.7°C (20°F) and 37.8°C (100°F) during testing. Peak wind speeds must be below 10 m/s (22.4 mph) to minimize target and test vehicle disturbance.

For daytime testing, ambient illumination must be at least 2,000 lux as measured on a plane parallel to the asphalt surface in the vicinity of the target. To prevent sun glare issues with camera-based vehicle sensors, the sun position must be ≥ 15 degrees above the horizon if the test vehicle is driving into the sun. For nighttime testing, illumination must remain below 1 lux throughout testing.

During testing, track-area ambient temperature, light level, and wind speed and direction are measured and recorded at 1-minute intervals.

TARGET

Pedestrian target system for P-AEB testing

IIHS uses 4active (4a) pedestrian test equipment for this test (see <http://www.4activesystems.at/en/>). Static and articulating-pedestrian dummies are shown in Figure 3. Pedestrian outer jackets must be free from rips, tears, deformation, and significant markings, which could affect test results. For nighttime testing, the adult-articulating pedestrian must include the black cover for the center tube.

Figure 3

Pedestrian targets



4activePA (child- and adult-articulating pedestrians)

4activePS (adult static pedestrian)

TEST VEHICLE PREPARATION

General

Tests are conducted using a new vehicle in the "as received" condition, with accumulated mileage between 200 and 5,000 miles as indicated on the odometer. Prior to beginning preparation and testing, IIHS ensures that:

1. The tires are new, original equipment tires inflated to the manufacturer's recommended cold inflation pressure. If more than one recommendation is provided, the tires are inflated to the lightly loaded condition.
2. The fuel tank is filled to at least 90% of capacity with the appropriate fuel and maintained to at least 75% capacity throughout the testing.
3. All other fluid reservoirs are filled to at least their minimum indicated levels.
4. Headlight aim is measured and recorded.

Instrumentation

An instrumented test vehicle includes a driver and all required equipment during testing. Where possible, the equipment is placed on the passenger side of the vehicle. The vehicle test weight should not exceed the vehicle curb weight by more than 200 kg (441 lbs).

Test vehicles are equipped with an Oxford Scientific RT-Range inertial and GPS/Locata navigation system to measure and record speed, longitudinal and lateral acceleration, longitudinal and lateral position, yaw rate, and impact time. These data are sampled and recorded at a frequency of 100 Hz.

A Racelogic Video VBOX Pro is used to overlay data obtained from the Oxford RT-Range onto video recorded at 30 FPS. One camera is positioned with a driver perspective facing out of the front windshield. Other cameras are used to verify impact and record forward collision warnings (FCW).

Table 2 lists the equipment used in the test vehicle.

Table 2

Test vehicle instrumentation

Measurement	Equipment
Speed	Oxford RT-Range
Longitudinal and lateral acceleration	Oxford RT-Range
Longitudinal and lateral position	Oxford RT-Range
Yaw rate	Oxford RT-Range
Impact time	Oxford RT-Range
Forward collision warning	Racelogic VBOX

IIHS uses a 4activeSB surfboard system for dynamic pedestrian tests to control and record dummy speed and position.

Brake warm-up and maintenance

Before testing, 10 stops are performed from a speed of 56 km/h (35 mph) with an average deceleration of approximately 0.5 to 0.6 g.

Immediately following the series of 56-km/h stops, three additional stops are performed from a speed of 72 km/h (45 mph) with sufficient brake pedal force to activate the vehicle's antilock braking system (ABS) for the majority of each stop.

Following the series of 72-km/h stops, the vehicle is driven at a speed of 72 km/h for 5 minutes to cool the brakes.

If at any point during testing the test vehicle remains stationary for longer than 15 minutes, a series of three brake stops are performed from a speed of 72 km/h, with an average deceleration of approximately 0.7 g to warm the brakes. During testing, a minimum of 3 minutes must elapse between the completion of the last warm-up stop and the onset of a test run and/or between the completion of each individual test run.

P-AEB initialization

Before P-AEB system performance can be properly assessed, some vehicles require a brief period of initialization. During this time, diagnostics to verify functionality and sensor calibrations are performed.

If system initialization is required, IIHS will obtain and perform the appropriate procedure from the vehicle manufacturer.

P-AEB and FCW system setting

P-AEB and/or FCW systems that have different in-vehicle settings for the timing of braking and/or warnings are set to the middle setting, or the next later setting if there is no middle setting.

TESTING

Pedestrian target speed

Pedestrian target test speeds are:

- 5 ± 0.2 km/h (considered walking speed) for the perpendicular adult scenario, and
- 5 ± 0.2 km/h (considered running speed) for the perpendicular child scenario.

Moving targets must accelerate to the test speed within 1 m from the start position, which is located 4 m laterally from the center of the test vehicle travel lane.

Target placement: perpendicular adult test

An adult pedestrian target is positioned 4 m laterally from the center of the test vehicle travel lane on a path perpendicular to the travel path of the test vehicle, crossing the lane from right-to-left, such that the test vehicle approaches the left side of the target and the vehicle's 25% overlap location intersects the vertical centerline of the target H-point at the impact/zero point. This scenario is illustrated in Figure 4a.

Target placement: perpendicular child test

A child pedestrian target is positioned 4 m laterally from the center of the test vehicle travel lane on a path perpendicular to the travel path of the test vehicle, crossing the lane from right-to-left, such that the test vehicle approaches the left side of the target and the vehicle's 50% overlap location intersects the vertical centerline of the target H-point at the impact/zero point.

Two vehicles from IIHS inventory are used to obstruct visibility of the target: (1) a small car and (2) a sport utility vehicle (SUV). The small car (1) is positioned 1 m longitudinally from the left edge of the target. The SUV (2) is positioned 1 m behind the small car (1). The left edges of both obstruction vehicles are aligned 0.2 m away from the right edge of the test lane. This scenario is illustrated in Figure 4b.

Target placement: parallel adult test

An adult pedestrian target is positioned on a line parallel to the travel path of the test vehicle, facing away, such that the vehicle approaches the rear of the target, with the target's median plane aligned with the vehicle's 25% overlap location. This scenario is illustrated in Figure 4c.

Figure 4

Target placement in each test scenario

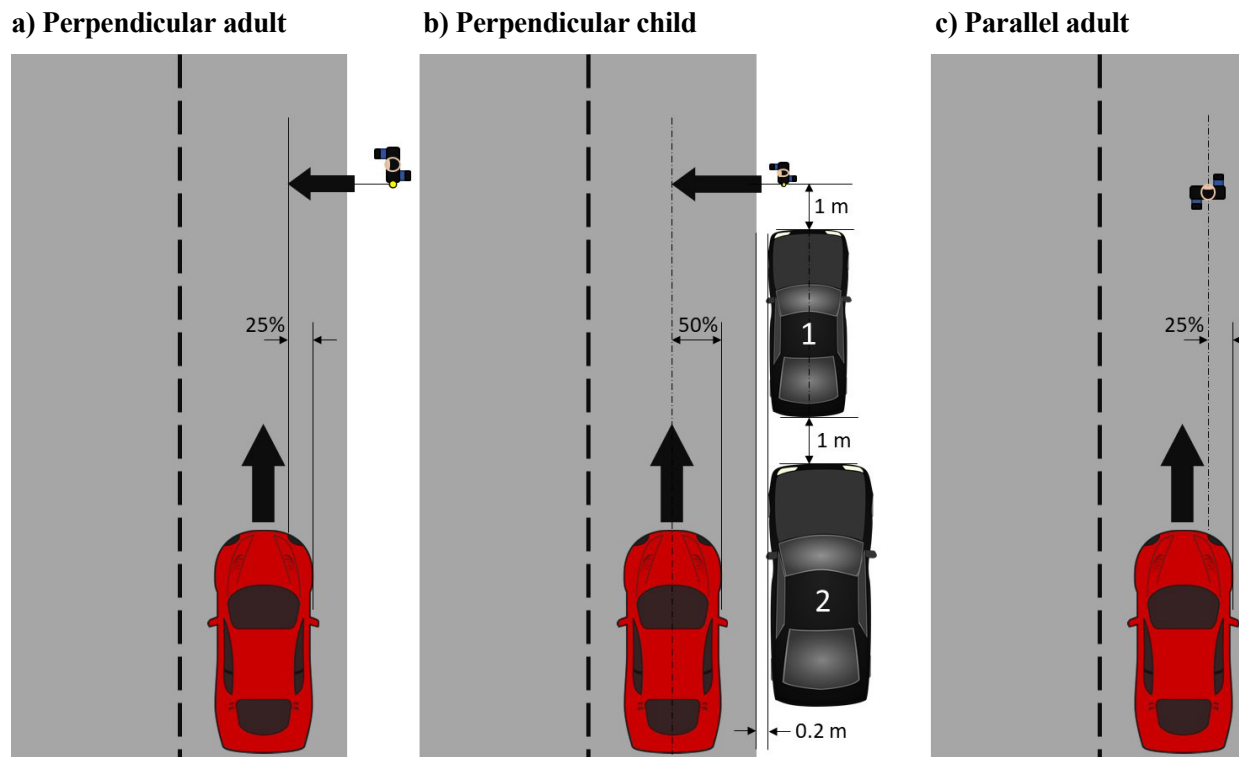

Test trials

A total of three valid runs are performed at each test speed in each lighting condition (day and night) and each headlight condition (high and low beams). For P-AEB systems that are not influenced by ambient lighting (i.e., radar only systems), nighttime tests may be conducted during the day. The overall speed reduction in each condition is calculated based on the average of all three test runs.

Test vehicle width and overlap position

The test vehicle's width is measured between the outermost body locations above the front wheel axle centerlines. Overlap position (25% or 50%) is based on a percentage of the vehicle's width measured from the front-right side.

Test vehicle speed

Tests are conducted at 20 and 40 km/h (perpendicular adult and perpendicular child scenarios), and at 40 and 60 km/h (parallel adult scenario).

Test vehicle approach

At the start of each test, the test vehicle begins moving between 150 and 200 m from the target and gradually accelerates toward the target. For 20-, 40-, and 60-km/h tests, the approach phase begins 25, 50, and 75 m (corresponding to approximately 4.5 s time-to-collision [TTC]) from the target, respectively. The approach phase ends when the test vehicle impacts the target, or the test vehicle stops before making impact with the target. During the approach phase, the driver is required to:

- modulate the throttle using smooth inputs to maintain the nominal test speed,
- use the least amount of steering input necessary to maintain the test vehicle in the center of the lane,
- avoid the use of abrupt steering inputs or corrections, and
- not touch the brake pedal.
- release the throttle at the start of braking.

For the test to be considered valid, the following criteria must be met during the approach phase until impact with the target or activation of autonomous braking:

- vehicle speed must remain within ± 1.0 km/h of the nominal test speed,
- yaw rate must remain within the range of ± 1 °/s,
- lateral distance between the centerline of the test vehicle and the centerline of the lane must not exceed ± 0.1 m, and
- pedestrian speed must remain within the range of 5.0 ± 0.2 km/h (except static target tests).

Activation of autonomous emergency braking

The point at which the vehicle longitudinal deceleration reaches 0.5 m/s^2 is considered the start of autonomous emergency braking.

Forward collision warning

Audible and visible forward collision warnings are monitored and recorded in a video file. Onset timing of whichever warning occurs first is recorded and used for scoring in some scenarios.

Impact point

The impact point is measured using the positioning system and is defined when and where the test vehicle first contacts the pedestrian target. A camera or tape switch can be used to verify impact. Prior to each test scenario, a zero point is established with the test vehicle and target aligned and touching at the impact location.

DATA ANALYSIS

Lateral and longitudinal positions

Lateral and longitudinal positions are measured in meters, and raw data are used to evaluate the vehicle position.

Longitudinal acceleration

Longitudinal acceleration is measured with an accelerometer in m/s^2 . Raw data are digitally filtered with a 12-pole phaseless Butterworth filter with a cutoff frequency of 6 Hz.

Speed

Speed is measured in km/h. Raw data are used to evaluate speed.

Speed reduction

Speed reduction is calculated by subtracting the test vehicle speed at the time of impact from the test vehicle speed prior to the activation of autonomous emergency braking. If the test vehicle does not contact the target, the impact speed is zero. The test vehicle speed prior to the activation of autonomous emergency braking is defined as the average speed calculated for 0.1 s immediately before autonomous emergency braking begins.

Yaw rate

The yaw rate is measured in degrees per second. Raw data are digitally filtered with a 12-pole phaseless Butterworth filter with a cutoff frequency of 6 Hz.

SCORING AND RATING SYSTEM

Points are awarded per Table 3 based on the average speed reduction of three test runs at each speed in each test scenario.

Decimal values of average speed reduction are truncated before awarding points. One additional point is awarded for vehicles with an average FCW timing greater than or equal to 2.1 seconds TTC in the three 60-km/h parallel runs. The average FCW TTC value is rounded to tenths of a second. Partial credit is not given for FCW.

Table 3
Points awarded for average speed reduction

Speed reduction range (km/h)			Points
0	to	8	0.0
9	to	18	0.5
19	to	28	1.0
29	to	38	1.5
39	to	48	2.0
49	to	58	2.5
59	to	61	3.0

Points are awarded for the daytime child scenario at both test speeds and the nighttime adult scenarios at all the test speeds with low and high beams (Table 4). Points are then weighted by multiplying the crossing-child and crossing-adult points by 2 (Table 5). Specific crossing- and stationary-adult points are further weighted based on the availability and speed range of high beam assist.

For vehicles with high beam assist, individual scores are multiplied by 2 based on the activation speed of the high beam assist. For instance, if high beam assist for a vehicle activates at 30 km/h or greater, the scores for high beam scenarios above 30 km/h are multiplied by 2 and the scores for low beam scenarios below 30 km/h are multiplied by 2. See the example in Table 6.

A maximum score of 42 is possible. The final weighted score is divided by 7 to get the rating. The final rating scale is shown in Table 7.

Table 4
Scoring — maximum points

	Crossing child		Crossing adult		Stationary adult		
	20 km/h	40 km/h	20 km/h	40 km/h	40 km/h	60 km/h	FCW
Night: High beams	NA	NA	1.0	2.0	2.0	3.0	1.0
Night: Low beams	NA	NA	1.0	2.0	2.0	3.0	1.0
Day	1.0	2.0	NA	NA	NA	NA	NA

Note. NA = not applicable (in Tables 4, 5, and 6).



Table 5
Weighting

	Crossing child (2x)		Crossing adult (2x)		Stationary adult		
	20 km/h	40 km/h	20 km/h	40 km/h	40 km/h	60 km/h	FCW
Night: High beams	NA	NA	2.0	4.0	2.0	3.0	1.0
Night: Low beams	NA	NA	2.0	4.0	2.0	3.0	1.0
Day	2.0	4.0	NA	NA	NA	NA	NA

Table 6
Weighting example with high beam assist (30-km/h activation speed)

	Crossing child		Crossing adult		Stationary adult		
	20 km/h	40 km/h	20 km/h	40 km/h	40 km/h	60 km/h	FCW
Night: High beams	NA	NA	2.0	8.0 (2x)	4.0 (2x)	6.0 (2x)	2.0 (2x)
Night: Low beams	NA	NA	4.0 (2x)	4.0	2.0	3.0	1.0
Day	2.0	4.0	NA	NA	NA	NA	NA

Table 7
Final rating scale

Total score range	Rating	Rating icon
Total score < 1	No credit	None
$1 \leq \text{total score} < 3$	Basic	
$3 \leq \text{total score} < 5$	Advanced	
Total score ≥ 5	Superior	

REFERENCES

Cicchino, J.B. (2022). Effects of automatic emergency braking systems on pedestrian crash risk. Insurance Institute for Highway Safety.

Highway Loss Data Institute. (2018). Effect of Subaru EyeSight on pedestrian-related bodily injury liability claim frequency. *HLDI Bulletin*, 34(39).